

# Catalogue 2021-22

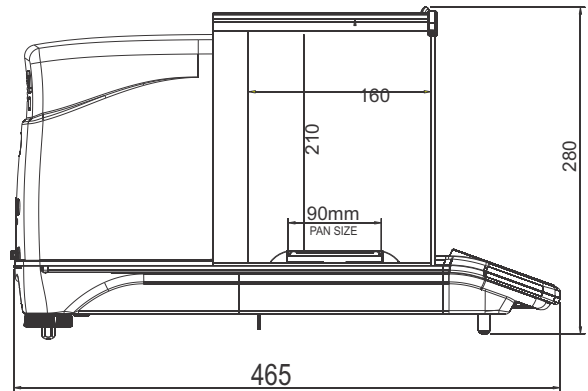















## MAB SERIES



### Semi Micro / Analytical Balance MAB220LCD & MAB250

### Semi Micro / Analytical Balance 50 / 220 g - 0.01 / 0.1 mg

-  Electro Magnetic Force Compensation
-  Statistic Weighing
-  Animal Weighing
-  Check Weighing
-  White Back Light LCD display
-  Percentage Weighing
-  Multiple Weighing Units
-  Density Determination Function
-  RS232C Interface
-  Counting Weighing mode
-  Temperature
-  Underhook Weighing
-  Calibration with Internal weight
-  Time
-  Date



#### Standard Accessories

- Instrument
- Pan
- Pan support
- Draft ring
- Dust guard
- Cleaning cloth
- Power Cord
- User manual



ID	12345
	2016/10/28 12:03
-----	
	001+0100.0000 g
	002+0100.0000 g
	003+0100.0000 g
	004+0100.0000 g
	005+0100.0000 g
-----	
N	005
AVR	+0500.0000 g
S	0000.000 g
MAX	+0100.0000 g
MIN	+0100.0000 g
DIF	0000.0000 g
-----	

# Catalogue 2021-22



## Semi Micro / Analytical Balance

HSN Code - 9016

MODEL	MAB220LCD	MAB250
Max. ( Capacity )	220 g	50 / 220g
Readability ( d )	0.0001 g	0.00001 / 0.0001 g
Repeatability ( ± )	0.2 mg	0.02 / 0.2 mg
Linearity ( ± )	0.4 mg	0.04 mg
Min. (Capacity)	10 mg	1 mg
Verification Scale Intervals (e)	1 mg	
Calibration	Motorized Internal Calibration	
Class	Class I	
Display	LCD with back light	
Make	WENSAR	
Response Time	4 - 6 Sec	
Pan Size (mm)	90 mm Ø	
Tare Range	Full	
Operating Temperature	+15 °C to +30°C	
Sensitivity Drift ±	2ppm / °C	
Density	Function Available	
Data Output Mode Selection	Command & Continuous Output	
Key Sound	Yes	
Weighing Chamber Height	210 mm	
Unit	g, oz, ct, lb, ozt, dwt, GN,	
Application Mode	PCS,%, Weighing, Animal Weighing, Check Weighing, Density, Statistics Weighing	
Baud rate Options	1200, 2400, 4800, 9600	
Interface	RS232C	
Power Supply	AC 220V / 50-60 Hz	
Dimension (LxWxH) mm	580 x 385 x 480	
Weight	13 Kg	

SPECIFICATIONS

★ Specifications are subject to change without notice.

\* Density Determination Kit for Solid & Liquid Sample (Optional)

Antivibration table must for Semi Micro Balance (MAB250)